

# RU-3000

Digital Universal Radiography System

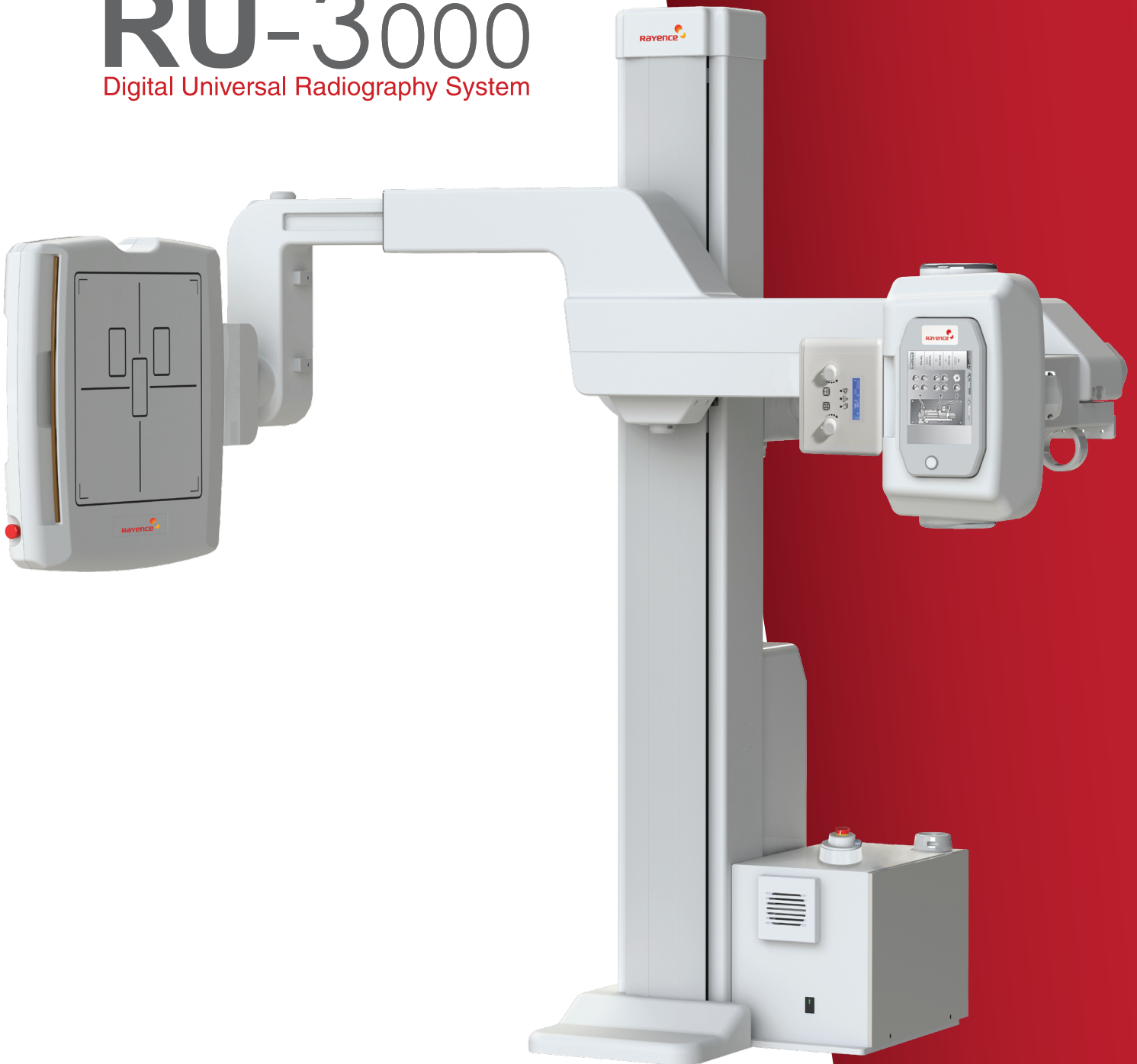

*EASE OF USE  
COST EFFECTIVE  
WORKFLOW EFFICIENT*

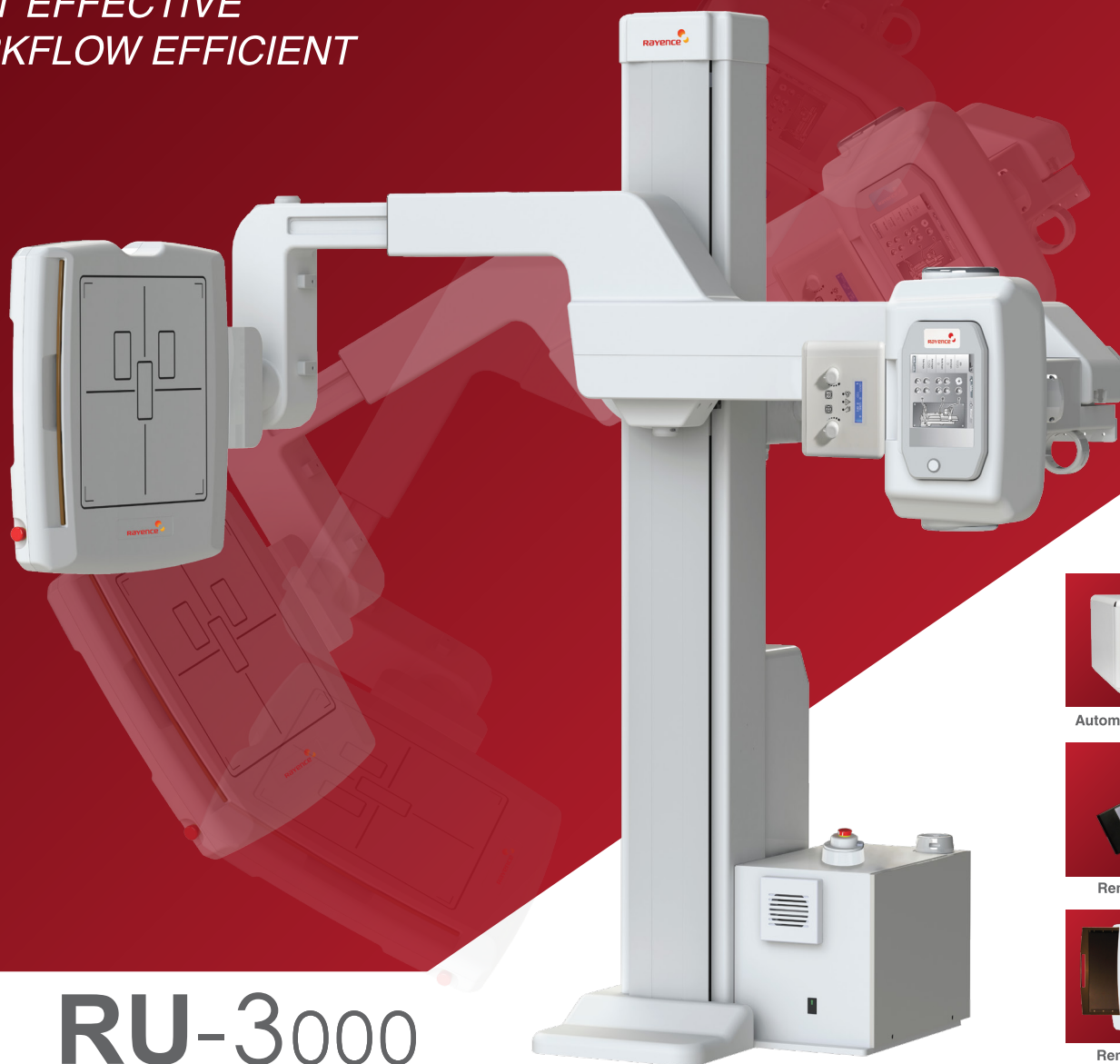

# RU-3000

Digital Universal Radiography System



Automatic Collimation



Remote Control



Removable Grid



Tubeside Control

## Universal Approach

The RU-3000 Digital Universal Radiography System is a cost effective, workflow efficient approach to digital radiographic imaging designed to improve patient workflow in orthopedic practices, imaging centers, medical clinics, and hospital environments.

## Unique Compact Design

The RU-3000's unique compact U-arm design features dual telescoping arm movement that permits installation in settings having ceiling heights of just eight (8) feet.

## Exceptional Image Quality

As a leading global manufacturer of digital detector solutions, Rayence provides the consistent image quality necessary for the most demanding environments. The RU-3000 comes equipped with a Rayence 17 x17 inch Cesium detector with 127 microns of resolution (3.9 lp/mm) enclosed in a durable detector assembly with an easily removable grid.

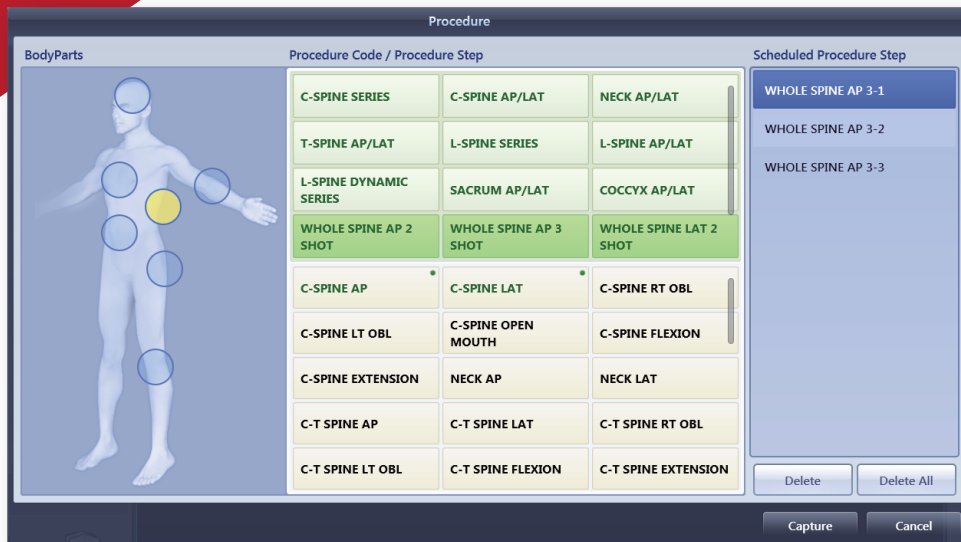

## Rayence XmaruView Software

Rayence XmaruView Image Acquisition Software provides optimized image quality through the use of exam specific algorithms and advanced image processing. This is complemented with touch-screen menus designed to streamline workflow such as APR (Anatomical Programmed Radiography), grid artifact suppression, programmable generator technique settings, and U-arm positioning control. Rayence XmaruView software is DICOM compliant which includes DICOM Store, DICOM Print and DICOM Modality Worklist.

### User-Specific, Automatic Positioning

The RU-3000's fully motorized movements for SID, arm rotation, height, and detector angle can be automatically programmed to user-specific radiographic positions utilizing the intuitive touch-screen located tube side, a hand held remote control, or by using the technologist workstation.



### Dynamic Mode

Using the new RU-3000's "Dynamic Mode" feature the technologist has the option to select the position of the detector angle, SID, gantry height and arm rotation from a graphic display on the technologist workstation. This is simply done by placing your finger on the particular component you want to move and sliding it to its desired position ("*Touch and Drag*" method).

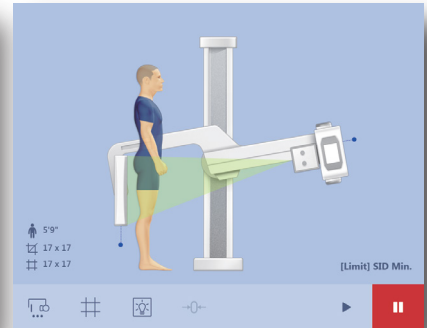
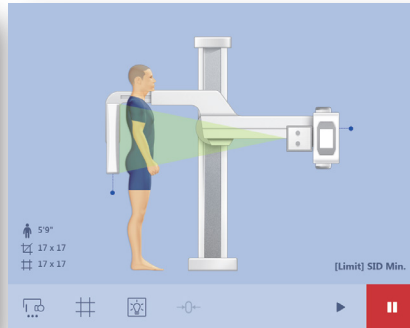
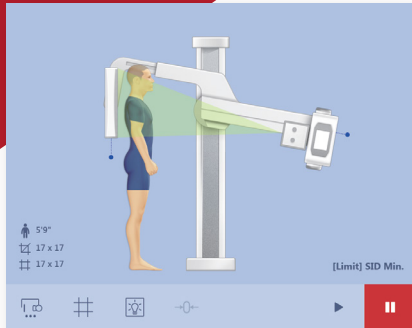

## Harmonic Stitching with Automatic Height Compensation (AHC)

The RU-3000 has the ability to be automatically positioned sequentially for spine and long-leg stitching examinations. Up to three exposure positions can be programmed. Automatic adjustment for different patient heights is obtained through the use of the RU-3000's Automatic Height Compensation (AHC) feature.

Image stitching is achieved by selecting one of three methods: Full-Auto, Semi Auto or Manual. To eliminate the exposure borders of each image due to varying densities, Rayence's advanced gradation process is automatically applied.

Together with Rayence's optional automatic stitching software, up to three views can be automatically stitched at a touch of a button, making stitching examinations easier than ever to attain.



→  
Stitching



→  
Gradation



## Automatic Collimation with Remote Collimator Control (RCC)

The RU-3000 comes with automatic collimation that is pre-programmed to the specific body part being examined by the way of the APR. The technologist can also remotely adjust, add and save a new preset from the technologist workstation using the RCC menu and employing the “Touch and Drag” method.

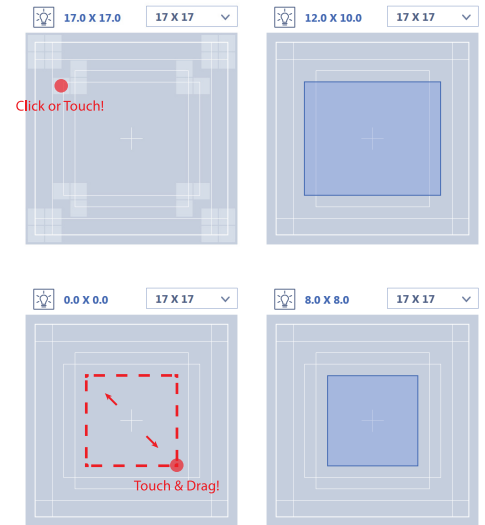
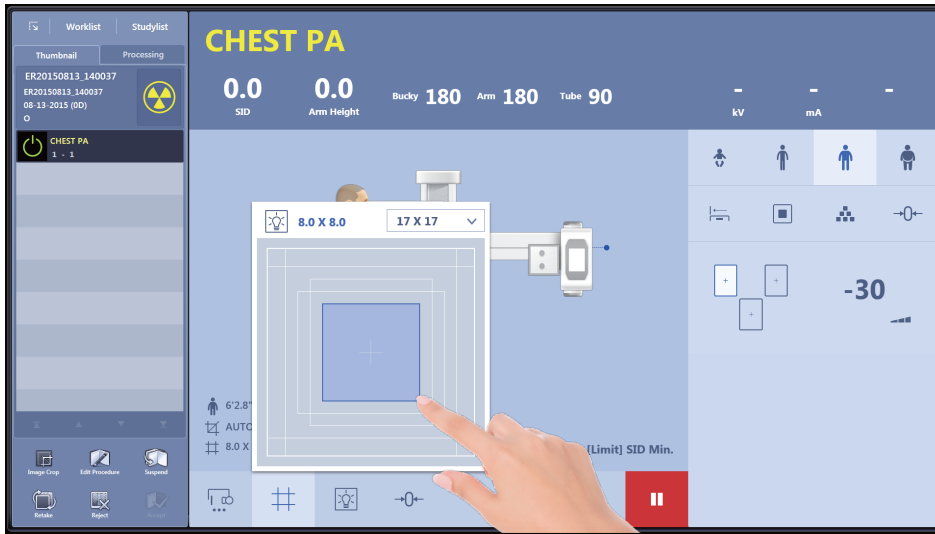

## Safety Features

Patient and operator safety comes first with the RU-3000. The RU-3000 is equipped with eleven (11) anti-collision motion sensors that can be adjusted for sensitivity, halting arm and detector motion when obstacles cross their path. In addition, two (2) emergency switches are strategically located should the operator need to immediately disable any movement of the unit.

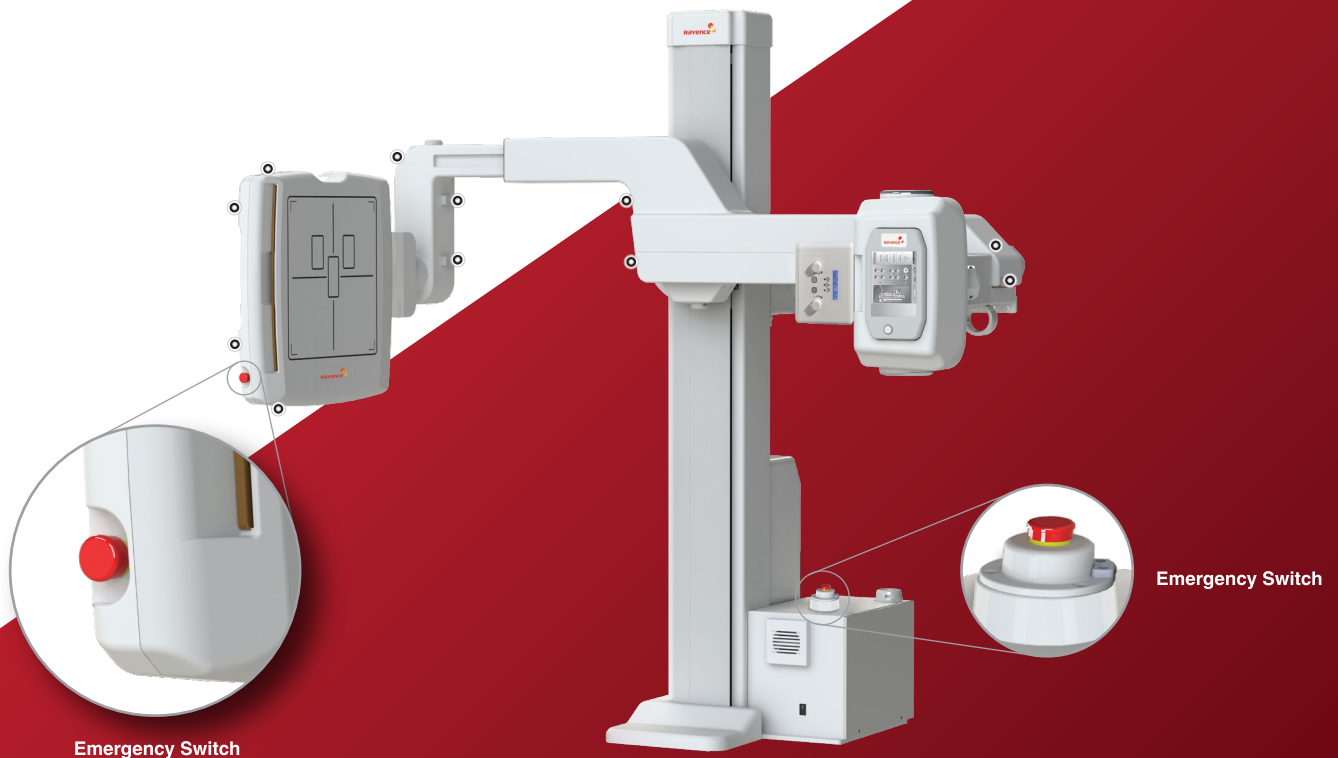



# RU-3000

## Specifications

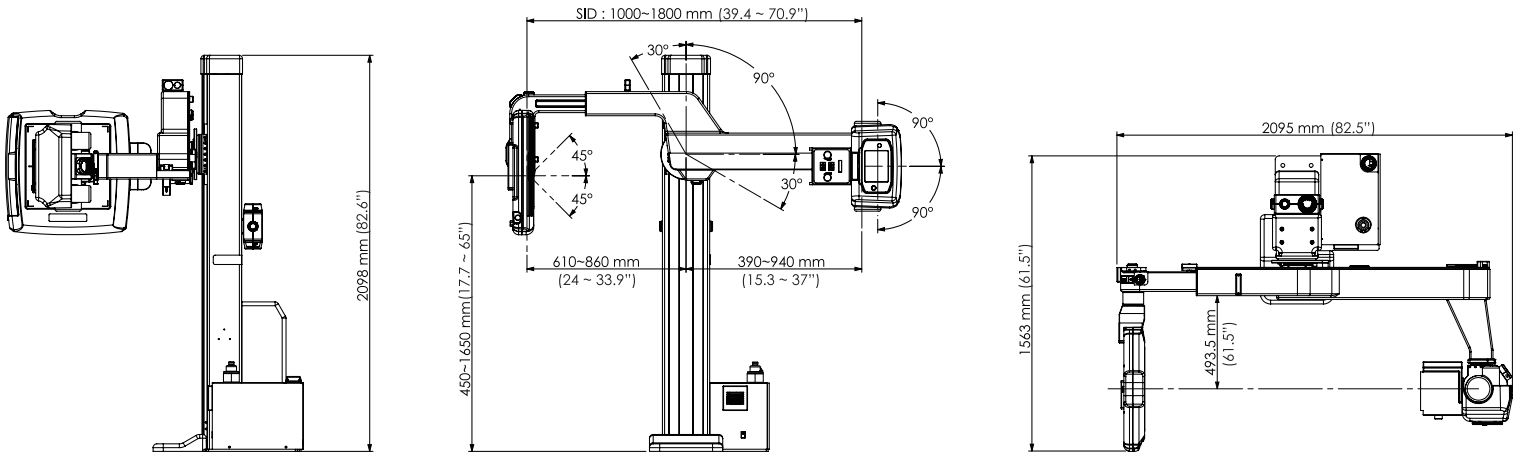

The RU-3000 is available with a wide variety of X-ray generators and tubes. It is intended to be used in a stationary diagnostic X-ray configuration.

U-arm Power Requirements : 1Ø, ~200-240V, 50/60 Hz

U-arm Incoming Power Line : 3 #14 AWG

Generator Power Requirements : 3Ø, ~400-480V, 50/60 Hz

Generator Incoming Power Line : 3 #14 AWG

Temperature Limits : 10°C ~ 40°C (50°F ~ 104°F)

Relative Humidity Limits : 30 ~ 75%

Atmospheric Limits : 700 hPa ~ 1060 hPa

Dimensions (W x L x H) : 1563 x 2098 x 2095 mm (61.5" x 82.6" x 82.5")

Weight : 570 kg (1257 lbs)

Equipment not suitable for use in the presence of flammable anesthetic mixtures with air, oxygen or nitro  
*\*specifications are subject to change without notice*

### Available Options:

- Mobile Table
- Weight Bearing Stand
- Stitching Stand
- Automatic Stitching
- DAP Meter
- AEC

US Standard units are approximate



10 22 RU3000 v1